

Metamodeling with Metamodels

Using

UML/MOF including OCL

Introducing Metamodels (Wikipedia)

- A metamodel is a model of a model
- An instantiation of metamodel gives a model
- Metamodeling is the process of generating such metamodels
- Metamodeling is the analysis, construction and development of the frames, rules, constraints, models and theories applicable and useful for modeling a predefined class of problems
- Metamodeling applies the notions of *meta-* and *modeling* in software engineering and systems engineering
- Metamodels are of many types and have diverse applications

Contributions of Object Management Group (OMG)

- In software engineering, the use of models is an alternative to more common code-based development techniques
- A model always conforms to a unique metamodel
- One of the currently most active branches of Model Driven Engineering is the approach named Model-Driven Architecture (MDA) proposed by OMG (Object Management Group)
- MDA utilizes the language Meta Object Facility (MOF) to write metamodels
- MOF roughly corresponds to the class diagram part of UML including OCL constraints
- Typical metamodels proposed by OMG are UML, OCL, SysML (Systems Modeling Language), or CWM (Common Warehouse Metamodel)
- Such languages can be defined as MOF metamodels, i.e., models formulated with MOF

Four Level OMG Model-Driven Architecture (MDA)

Layer	Description	Example
meta-metamodel M3 / MOF	The infrastructure for a metamodeling architecture. Defines the language for specifying metamodels.	<i>MetaClass, MetaAttribute, MetaOperation</i>
metamodel M2 / UML	An instance of a meta-metamodel. Defines the language for specifying a model.	<i>Class, Attribute, Operation, Component</i>
model M1 / User model	An instance of a metamodel. Defines a language to describe an information domain.	<i>StockShare, askPrice, sellLimitOrder, StockQuoteServer</i>
user objects (user data) M0	An instance of a model. Defines a specific information domain.	<i><Acme_SW_Share_98789>, 654.56, sell_limit_order, <Stock_Quote_Svr_32123></i>

Model-Driven Architecture (MDA) – Analogy Programming

Layer	Analogy Programming Languages	Example
meta-metamodel M3 / MOF	EBNF notation for context-free grammars (Extended Backus-Naur Form)	<i>MetaClass, MetaAttribute, MetaOperation</i>
metamodel M2 / UML	Syntax definition of one programming language with context-free grammar in EBNF notation, e.g. PASCAL or JAVA	<i>Class, Attribute, Operation, Component</i>
model M1 / User model	One specific JAVA program J	<i>StockShare, askPrice, sellLimitOrder, StockQuoteServer</i>
user objects (user data) M0	One execution of JAVA program J	<i><Acme_SW_Share_98789>, 654.56, sell_limit_order, <Stock_Quote_Svr_32123></i>

Four Level OMG Model-Driven Architecture (MDA)

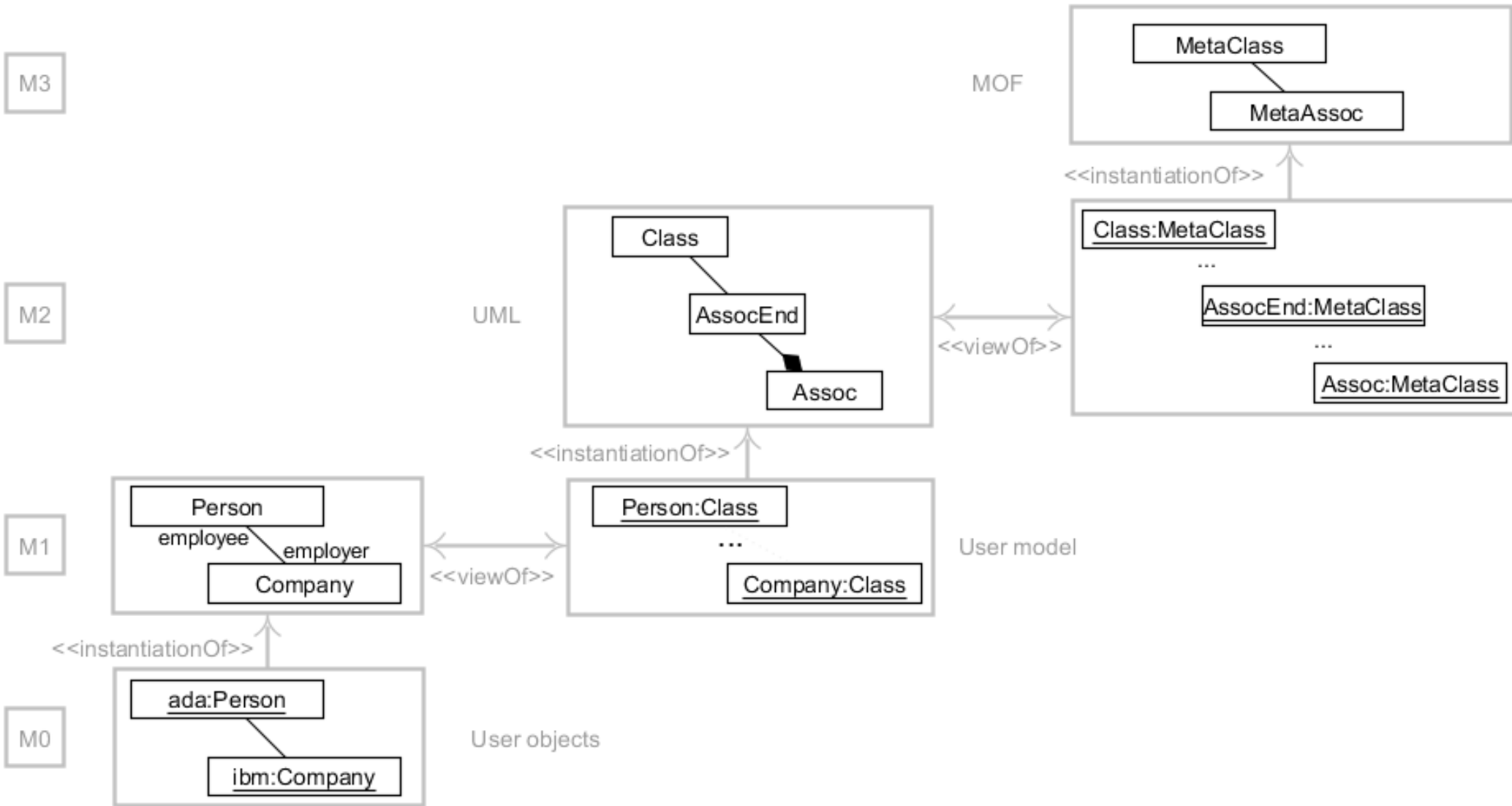

Class diagram understood as MM (MetaModel) object diagram

- Usual work with class diagrams
 - define first the class diagram
 - develop then various object diagrams
 - tune the class diagram to meet developer needs
- Approach within metamodeling

consider the concepts appearing in a class diagram (class, attribute, association, ...)

describe these concepts and their relationships again with a class diagram

if class diagrams are a powerful mechanism, why should one not describe class diagrams with class diagrams

Class diagram understood as MM (MetaModel) object diagram

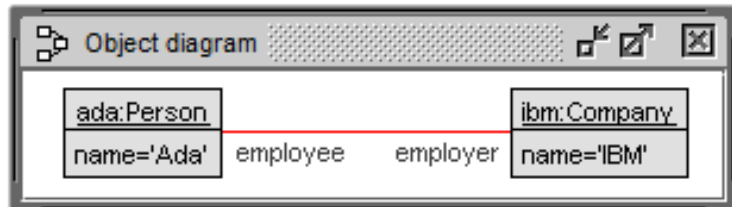
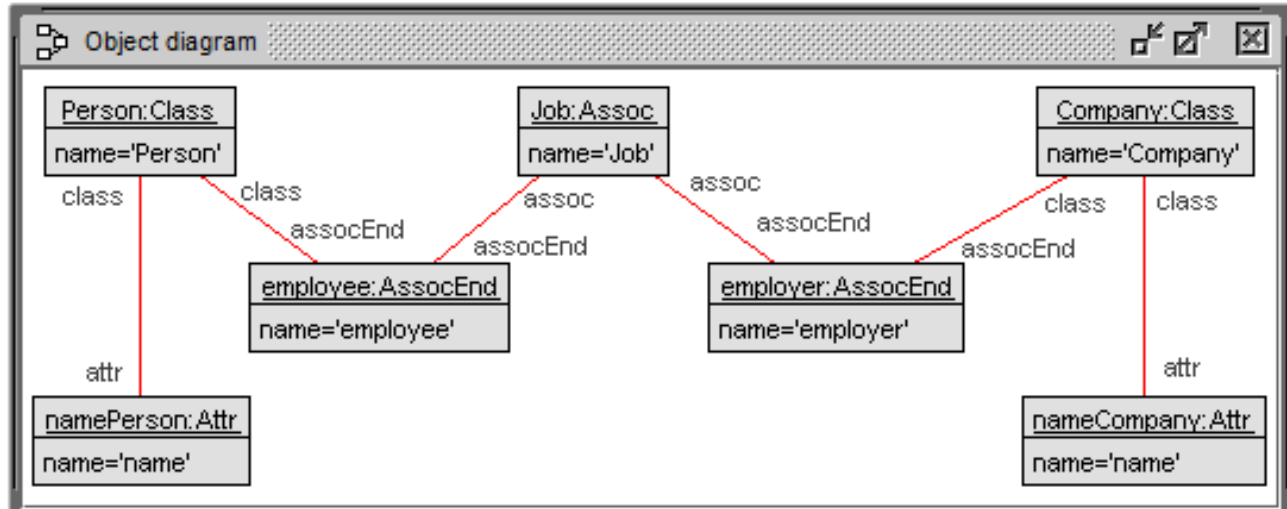
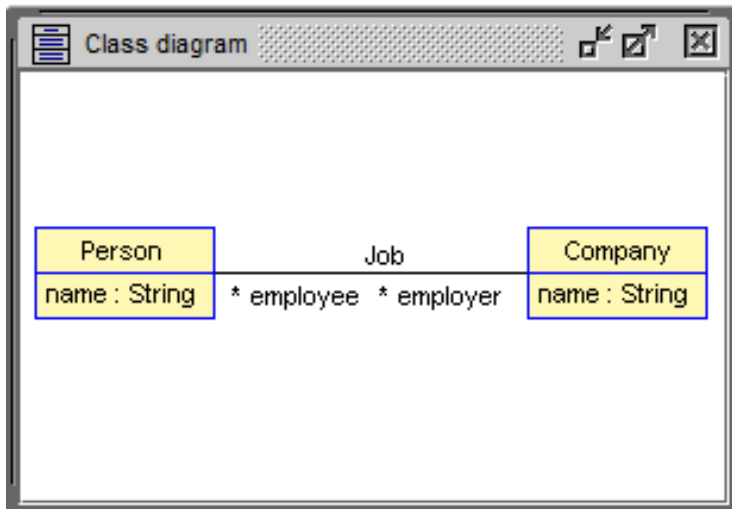
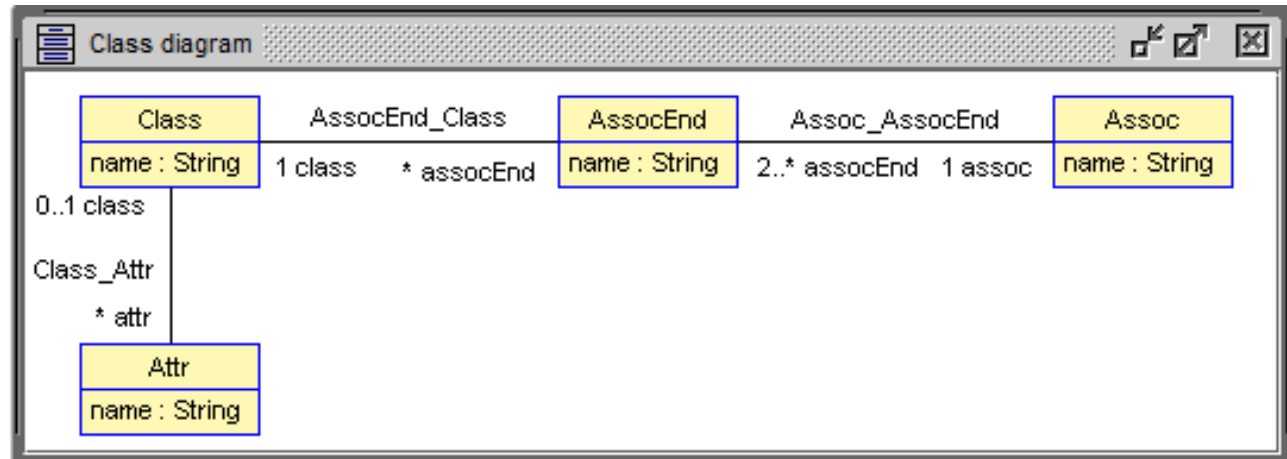

MM Extension: Generalization, Association class

- First MM (4 classes) described classes, attributes, associations, and associations ends
- Consider now also further concepts: generalization between classes and association classes
- Apply invariants in order to achieve only valid class diagrams
- Attribute names within a class are unique
- Attribute name and association end names are different
- Generalization hierarchies are acyclic
- Optional: Exclude multiple inheritance
- Overall result: CD plus the stated invariants determine a set of valid objects diagrams; this set of object diagrams builds the defined (modeling) language
- THUS: Metamodeling is an approach for language development

MM Extension: Generalization, Association class

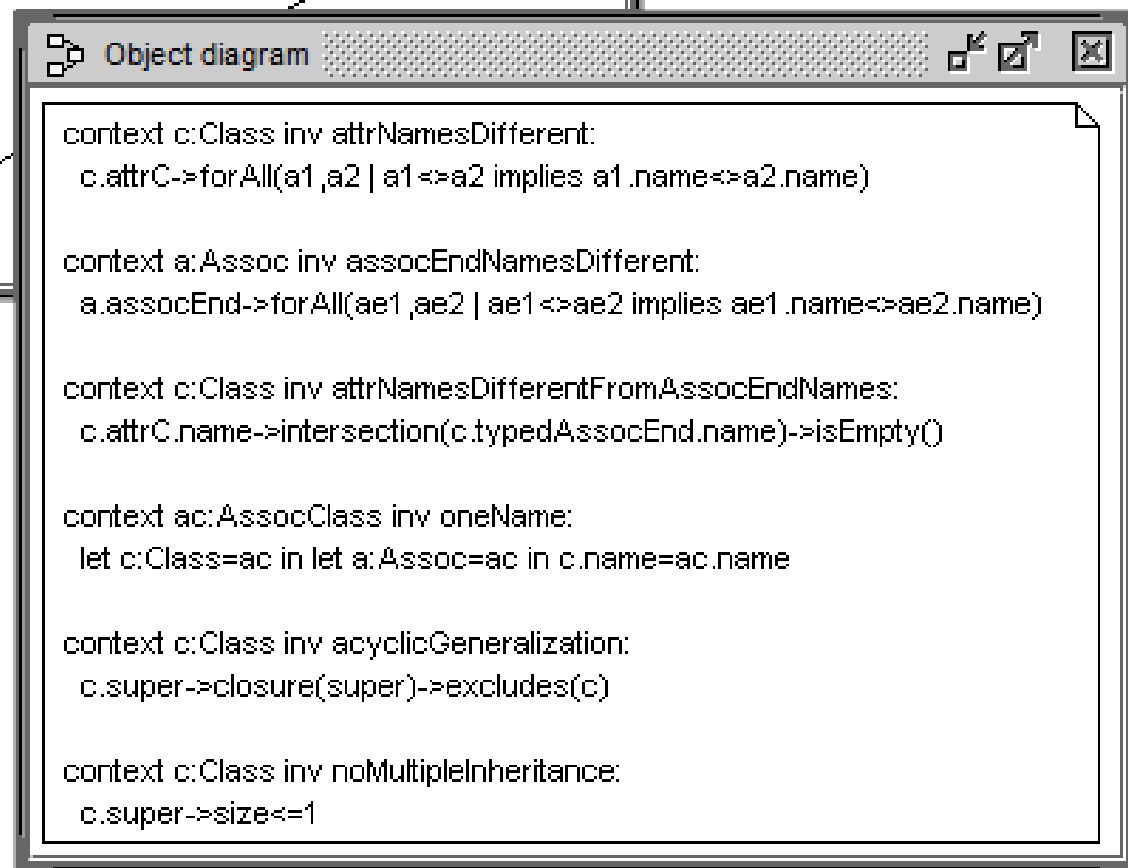
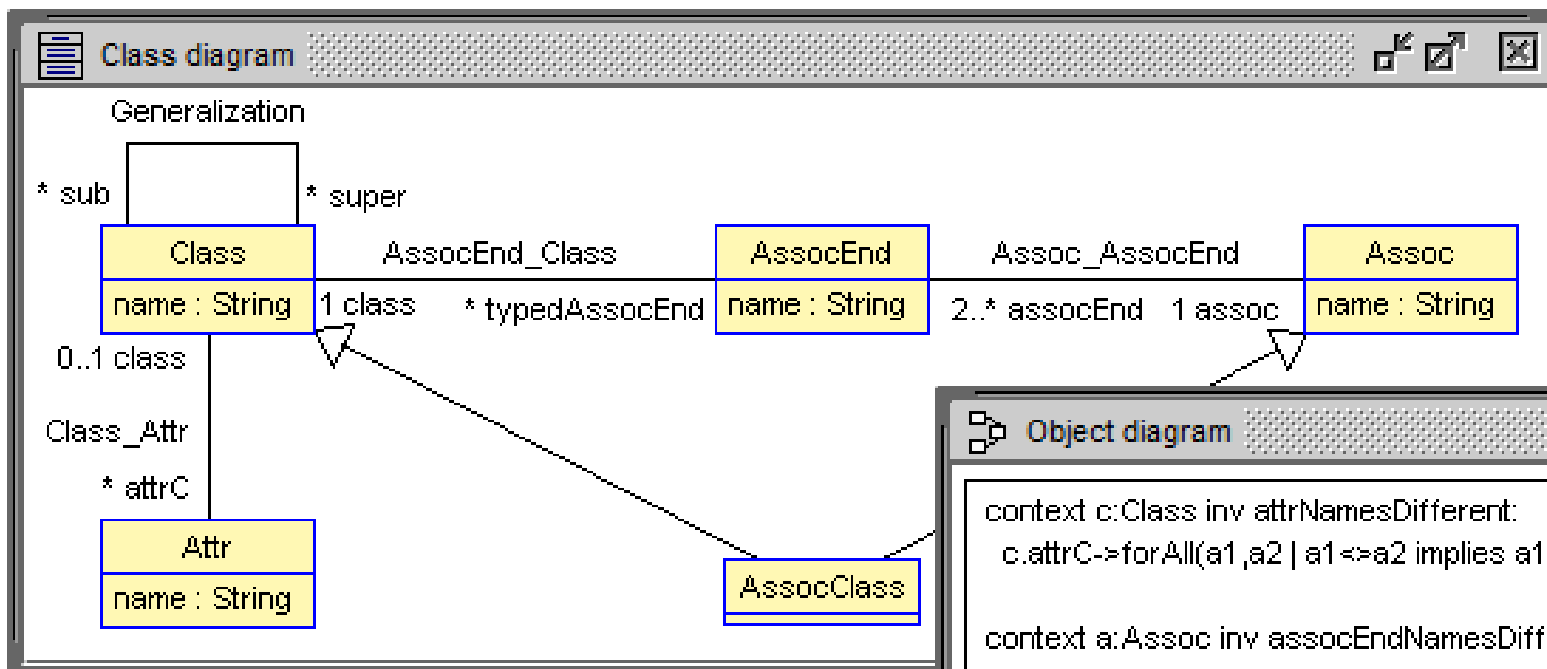

Proper UML 2.4 Metamodel (more complicated)

- UML is defined by a class diagram plus restricting OCL invariants
- This class diagram is called the 'UML Metamodel (MM)'
- UML was developed over the recent years by the OMG
- Various versions were published

UML 1.1, UML 1.2, ..., UML 2.0, ..., UML 2.4, ...

UML 2.4 is an important and well accepted version

- UML uses a different terminology (different class and association end names) than the motivating simple metamodel used above
- Attribute and AssociationEnd objects are commonly treated as Property objects; a Property object 'lives within' a class (then it is an attribute) or the Property object 'lives within' an association (then it is an association end); 'lives within' = composition / black diamond

Proper UML 2.4 Metamodel (more complicated)

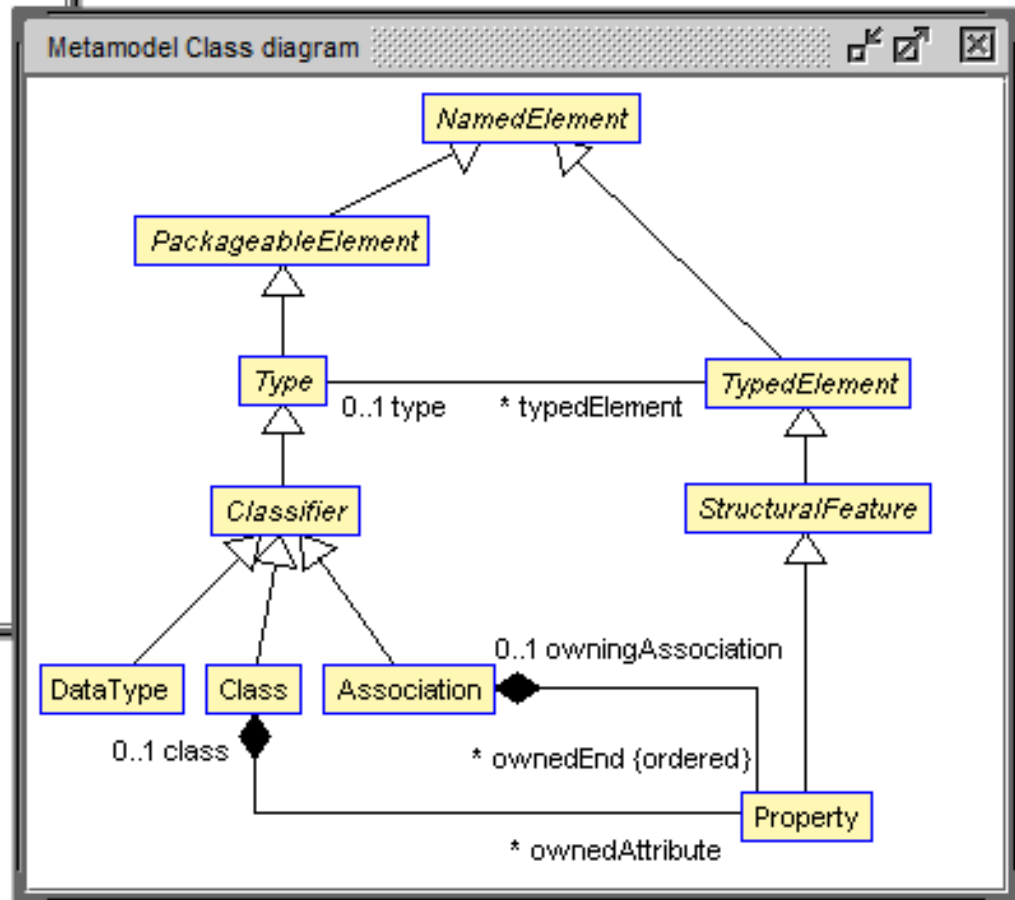
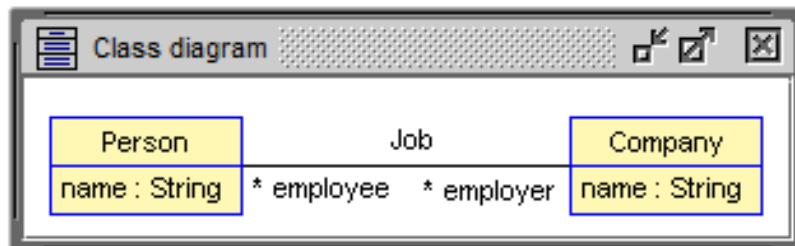
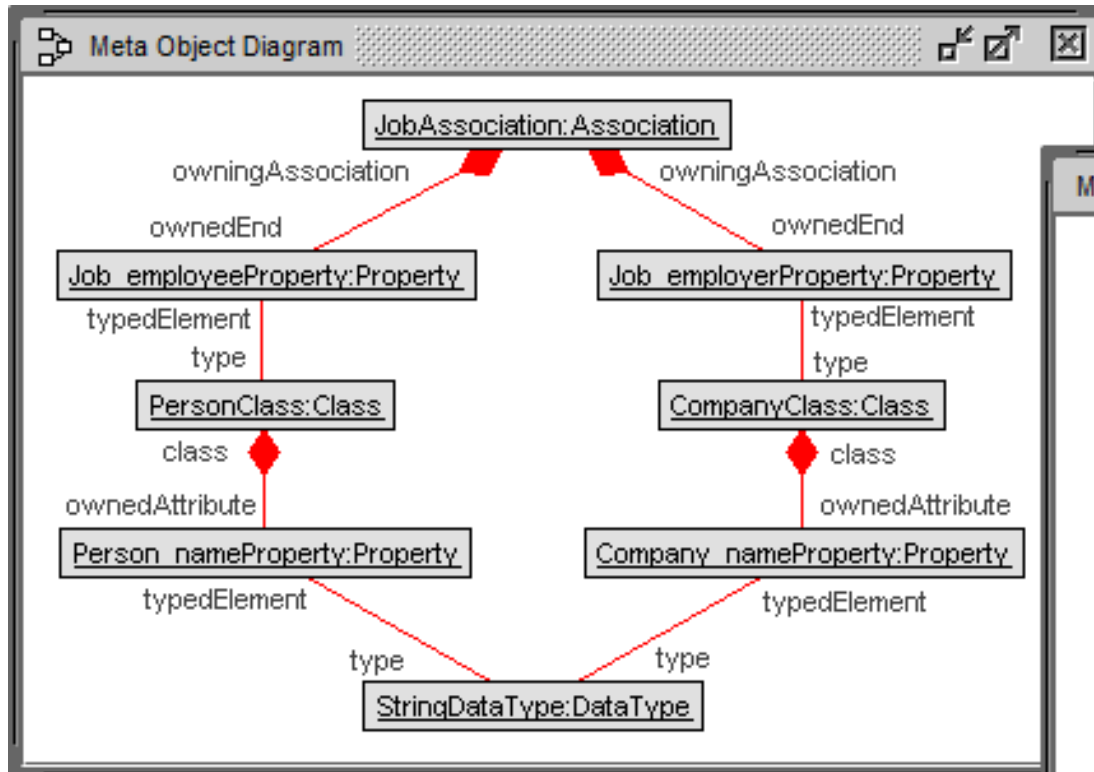

Options through representing CDs with object models

- OCL expressions can be stated on the object diagram representing the class diagram
- USE version available that incorporates UML 2.4 MM and can represent a user class diagram as a UML 2.4 MM object diagram
- Which are the association end names of a given association?
- What are all the class names together with the classes associations end names?
- What are all the class names together with the classes attribute names?
- Which properties (attributes and association ends) are typed through which classes?
- Which properties are typed through Datatypes?
- Such OCL expressions can represent generally interesting features of a class diagram, independent of the particular considered class diagram

OCL expressions for example class diagram

Object diagram

JobAssociation.ownedEnd

OrderedSet{Job_employeeProperty,Job_employerProperty} : OrderedSet(Property)

JobAssociation.ownedEnd.name

Sequence{'employee','employer'} : Sequence(String)

Class.allInstances->collect(c|Tuple{N:c.name,A:c.typedElementoclAsType(Property).name})

Bag(Tuple{N='Person',A=Bag{'employee'}},Tuple{N='Company',A=Bag{'employer'}}) : Bag(Tuple(N:String,A:Bag(String)))

Class.allInstances->collect(c|Tuple{N:c.name,A:c.typedElementoclAsType(Property).association.name})

Bag(Tuple{N='Company',A=Bag{'Job'}},Tuple{N='Person',A=Bag{'Job'}}) : Bag(Tuple(N:String,A:Bag(String)))

Class.allInstances->collect(c|Tuple{N:c.name,A:c.ownedAttributeoclAsType(Property).name})

Bag(Tuple{N='Company',A=Sequence{'name'}},Tuple{N='Person',A=Sequence{'name'}}) : Bag(Tuple(N:String,A:Sequence(String)))

Class.allInstances.typedElement

Bag{Job_employeeProperty,Job_employerProperty} : Bag(Property)

DataType.allInstances.typedElement

Bag{Company_nameProperty,Person_nameProperty} : Bag(Property)

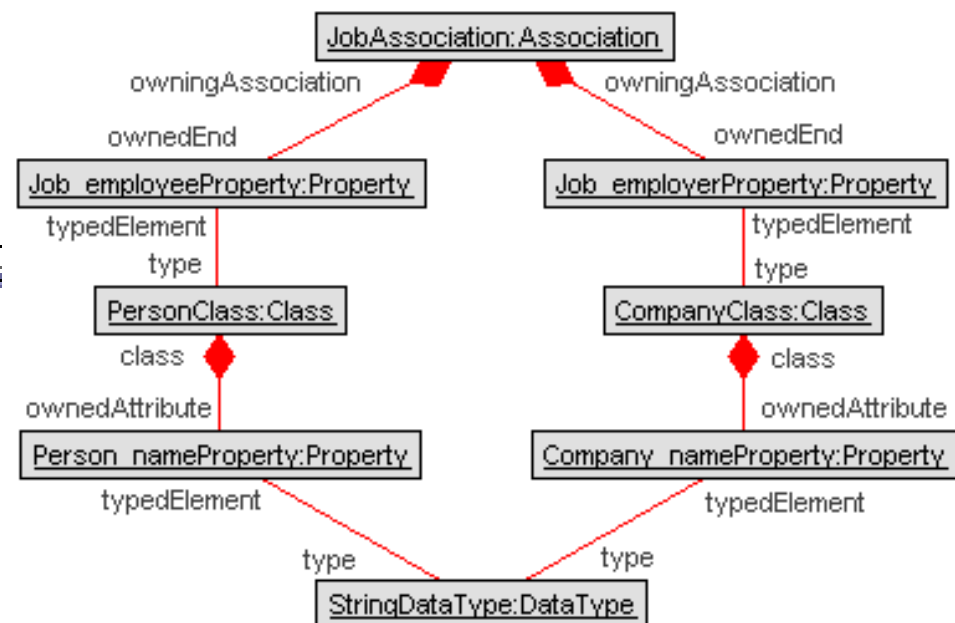

Attributes in UML 2.4 MM

- The above object diagram (for Person-Job-Company) showed only the objects and links, but not the attributes
- Some details follow ...
- Attribute name (all classes) gives name in form of a String
- Lower and upper bounds of association ends are represented by the Integer attributes 'lower' and 'upper' (for Property); upper value '-1' represents '*'
- Attribute 'aggregation' (for Property) distinguishes between 'association', 'aggregation' and 'composition': #none, #shared, #composite (enumeration)
- Boolean attribute 'isAbstract' (for Class) specifies whether the class is abstract or not

Attributes in UML 2.4 MM

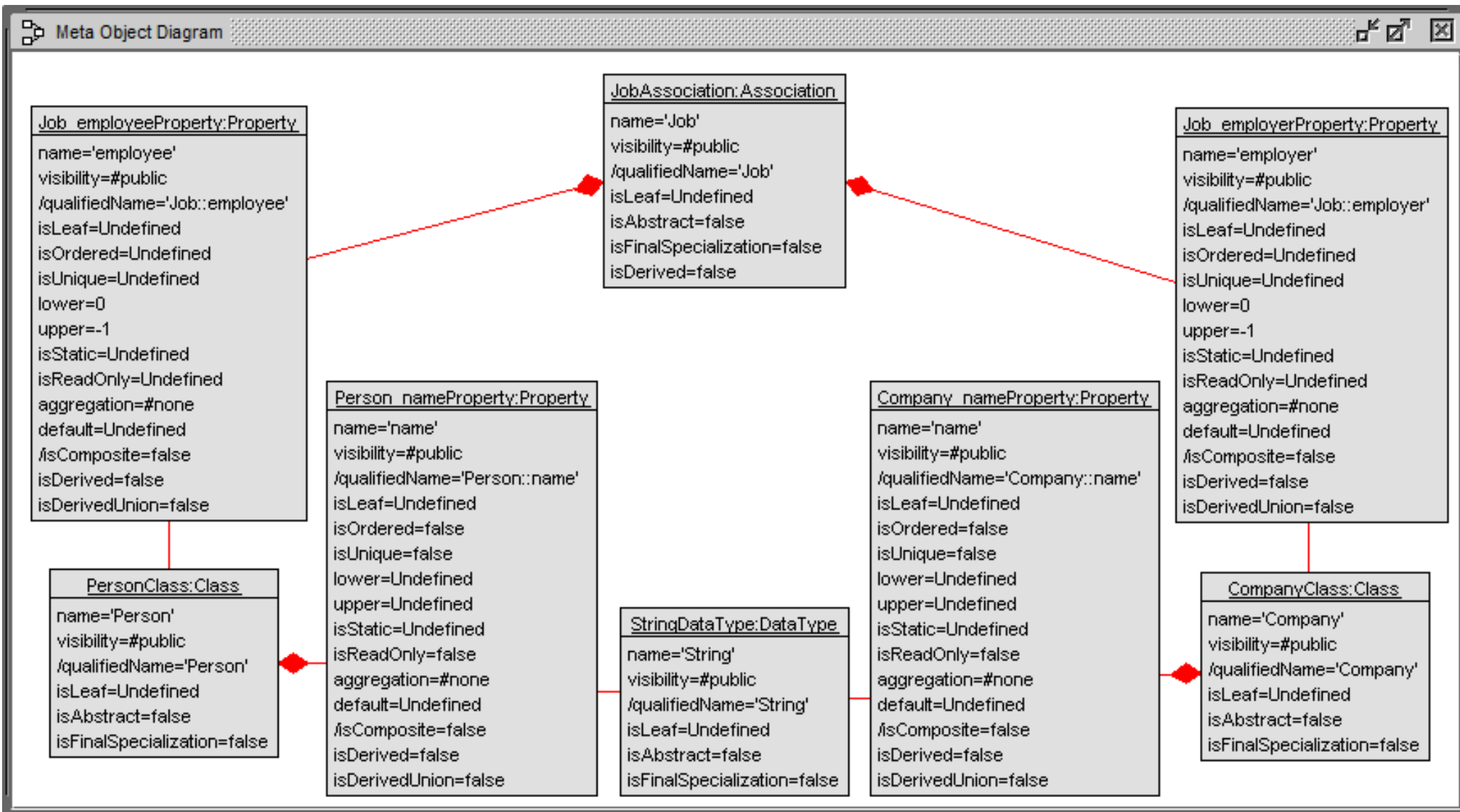

Central elements of UML 2.4 MM

- Much more classes and associations are part of the UML 2.4 MM than the ones that have been shown
- Some details follow ...
- Property < StructuralFeature < TypedElement
- Class < Classifier < Type
- Association:
Type role [0..1] type – TypedElement role [0..*] typedElement
StringDataType:DataType<Type role type –
Person_nameProperty:Property<TypedElement role typedElement

Central elements of UML 2.4 MM

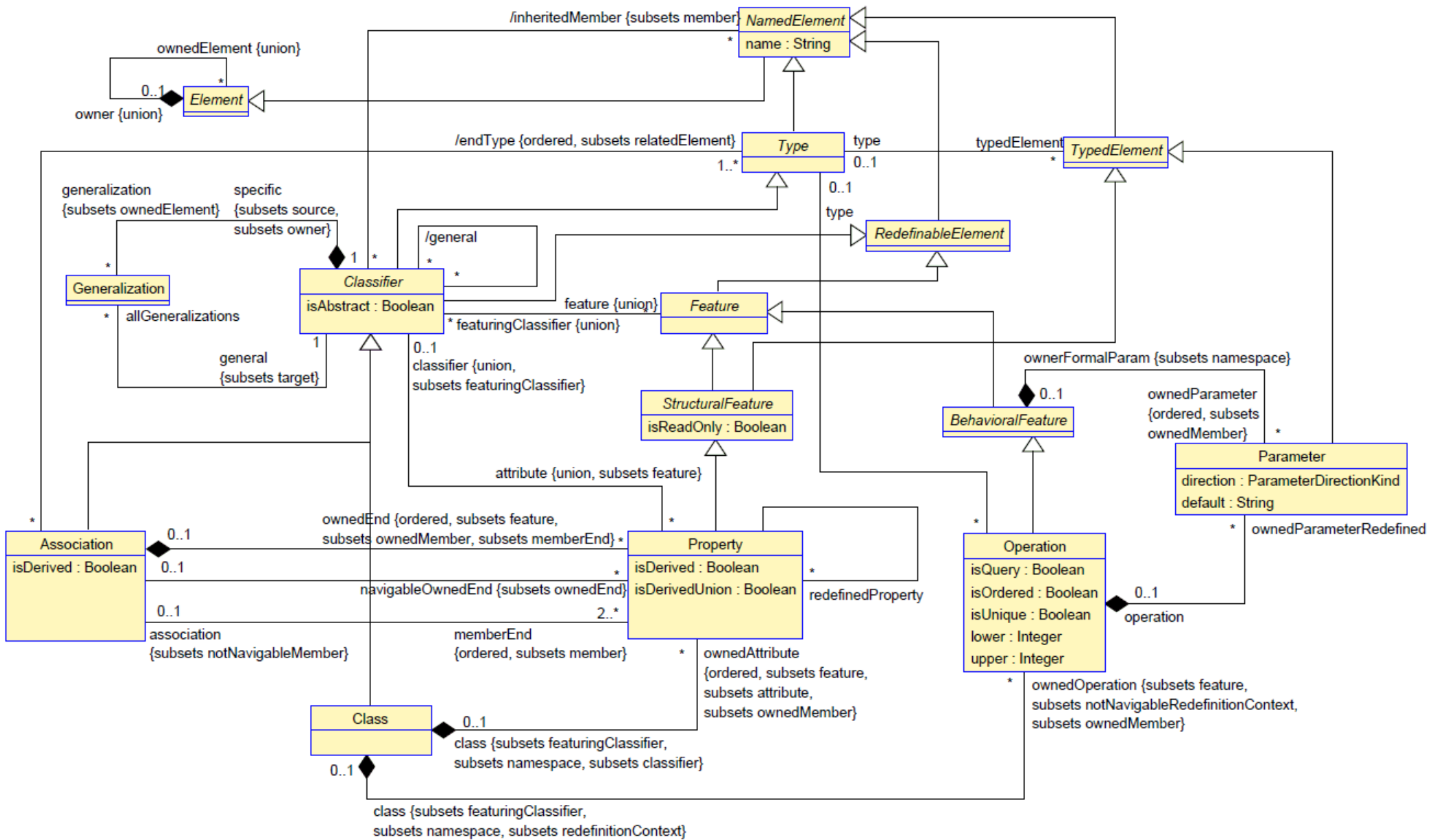

UML 2.4 MM: All classes and associations

- UML 2.4 MM available as a USE model
- 63 classes
- 99 associations
- 54 invariants
- 66 operations

UML 2.4 MM: All classes and associations

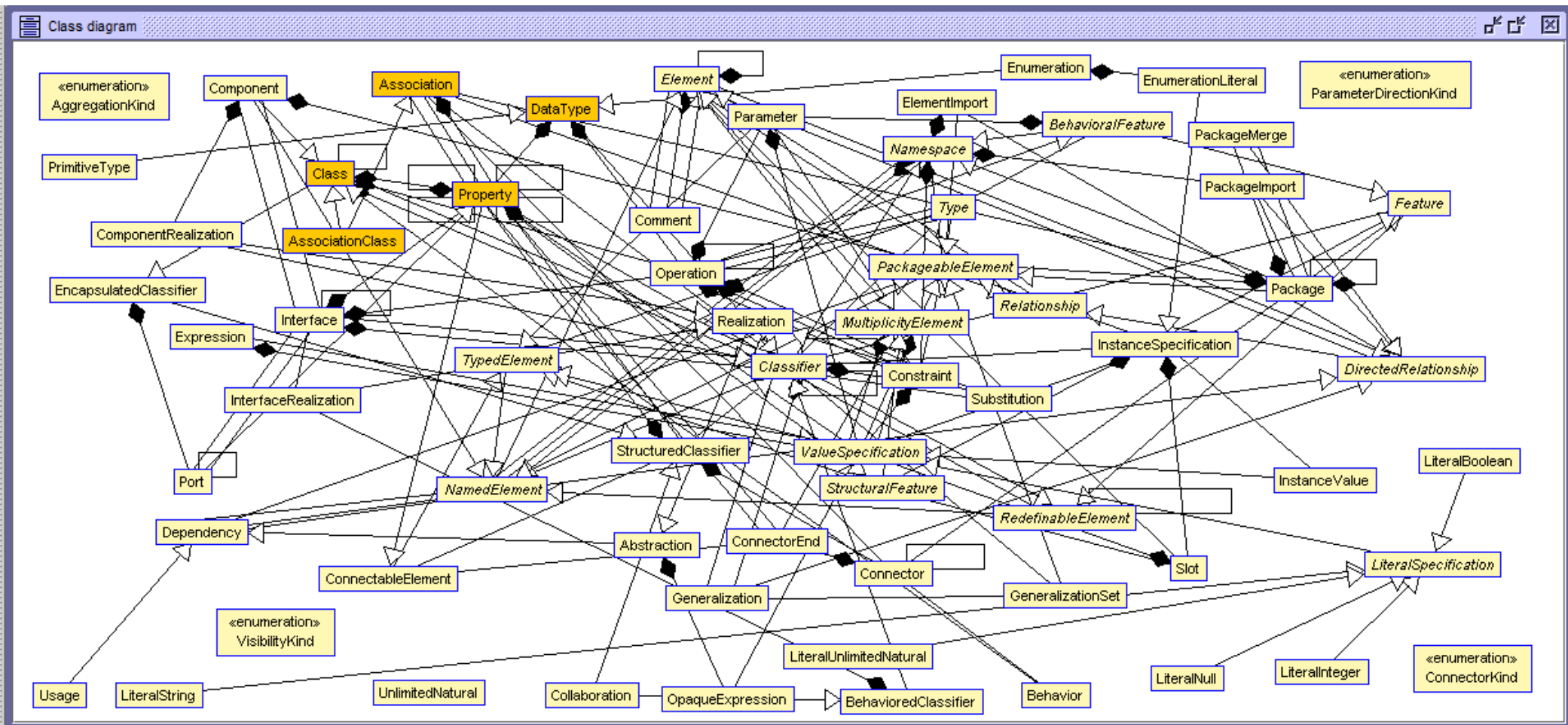

Log
compiling specification C:\Users\Gogolla\Desktop\use-4.2-metamodeling\Metamodels\UML2MM.use...
done.
Model UML_MetaModel (63 classes, 99 associations, 54 invariants, 66 operations, 11 pre-/postconditions, 0 state machines)

UML 2.4 MM CD complex – Building views gives overview

- Classes with more than one subclass
- Classes with more than one superclass (multiple inheritance used!)
- Classes being 'simple' specializations
class c with 'c.sub->isEmpty and s.super->size=1'
- Classes involved in at least 2 generalizations

- At the top of the generalization hierarchy is 'Element'
- Subclasses realize particular functionality; examples follow ...
- NamedElement (with attribute 'name')
- MultiplicityElement (with attributes 'lower' and 'upper')
- TypedElement (with association typedElement - type)

Classes with more than one superclass

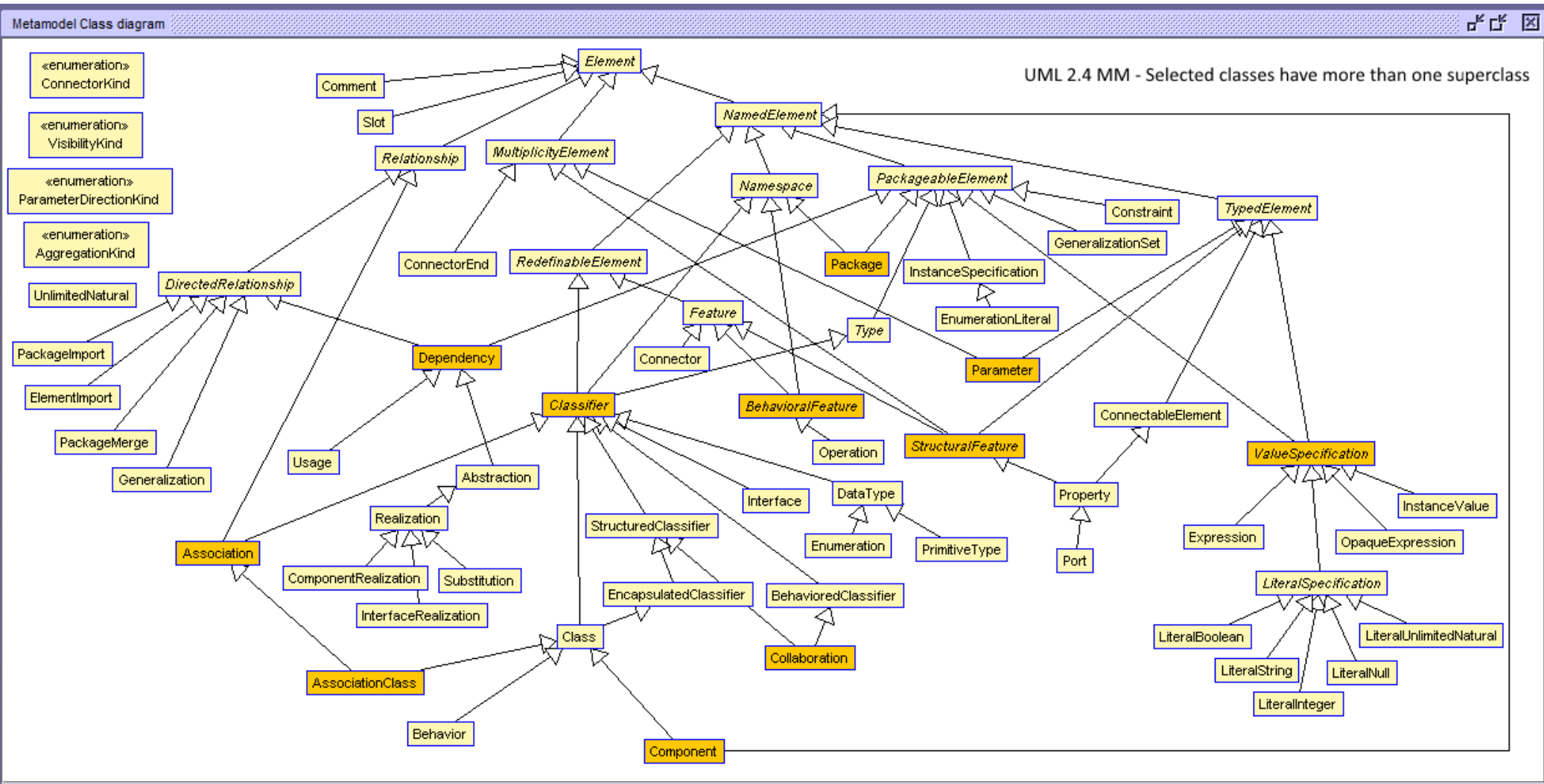

Classes being 'simple' specializations

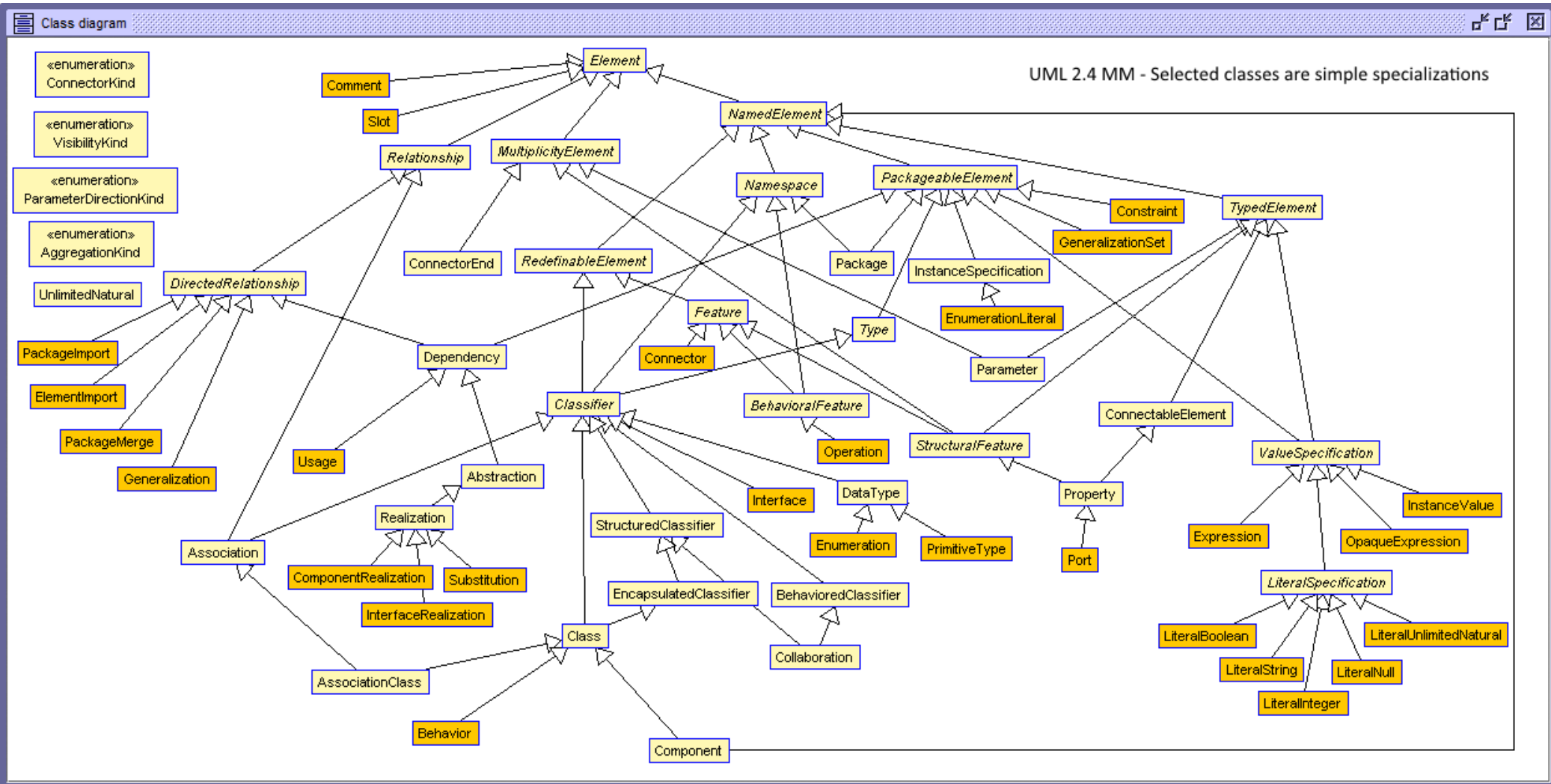

Classes involved in two Generalizations

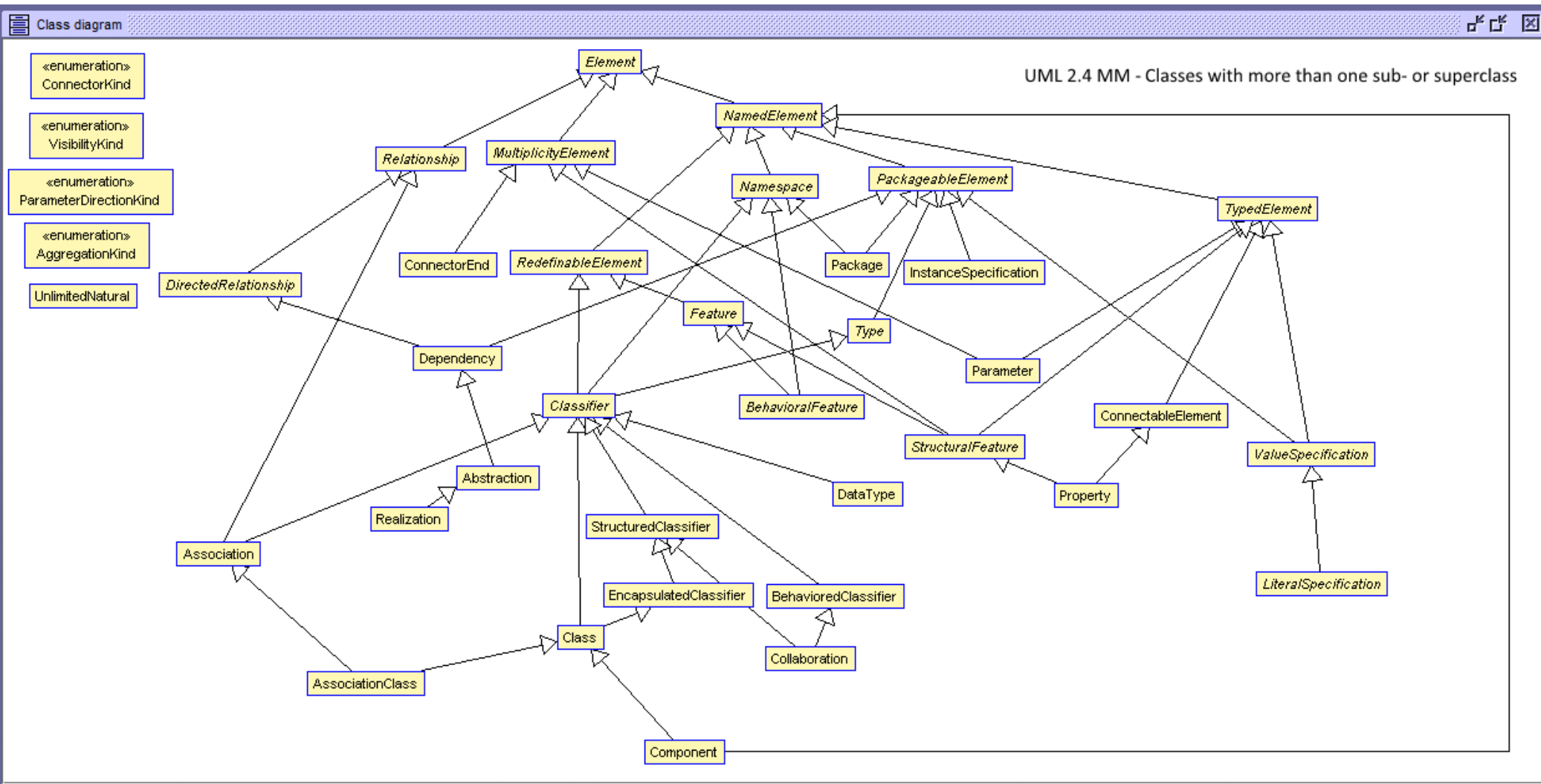

Manifestation of OMG Four Level through USE-MM

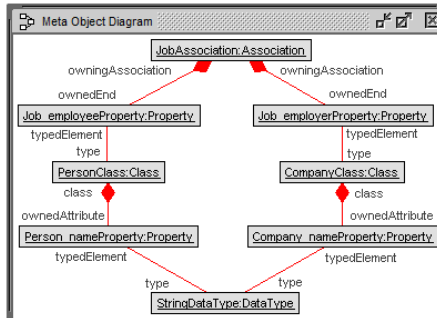
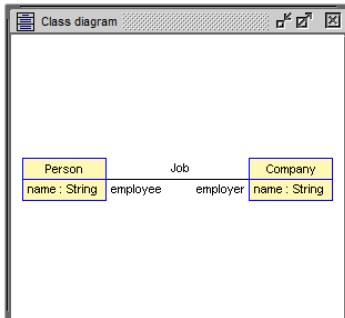
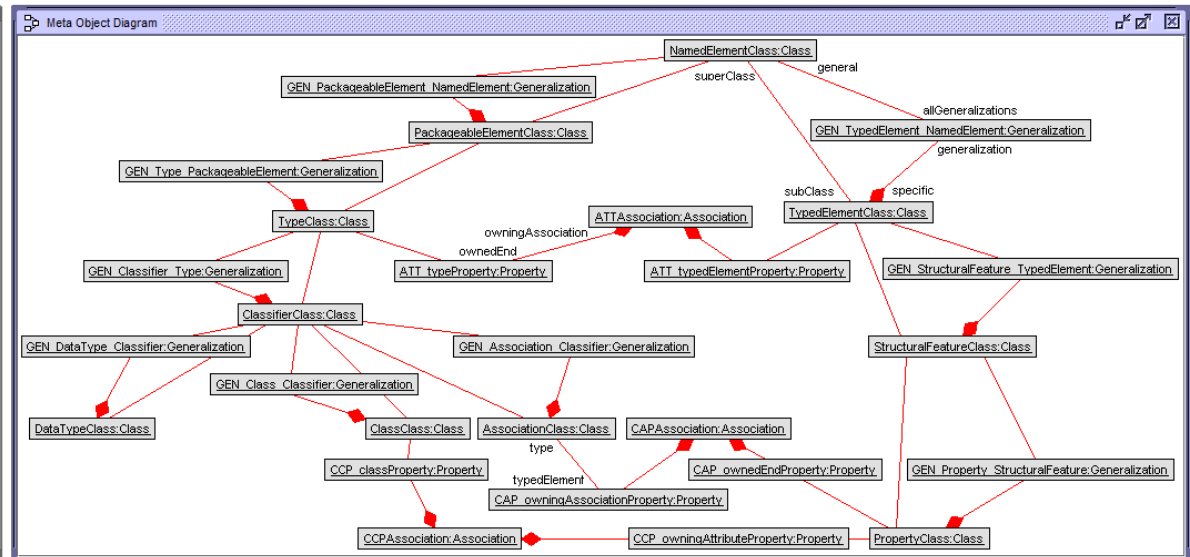
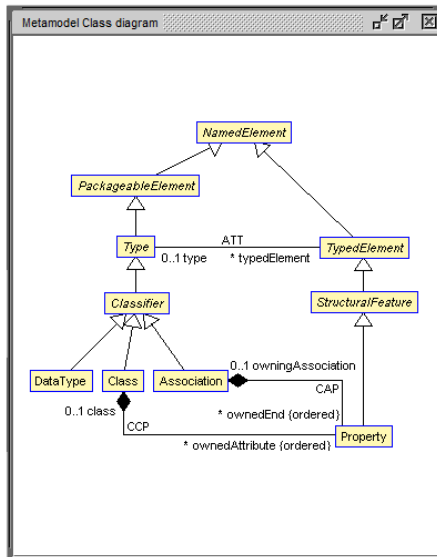
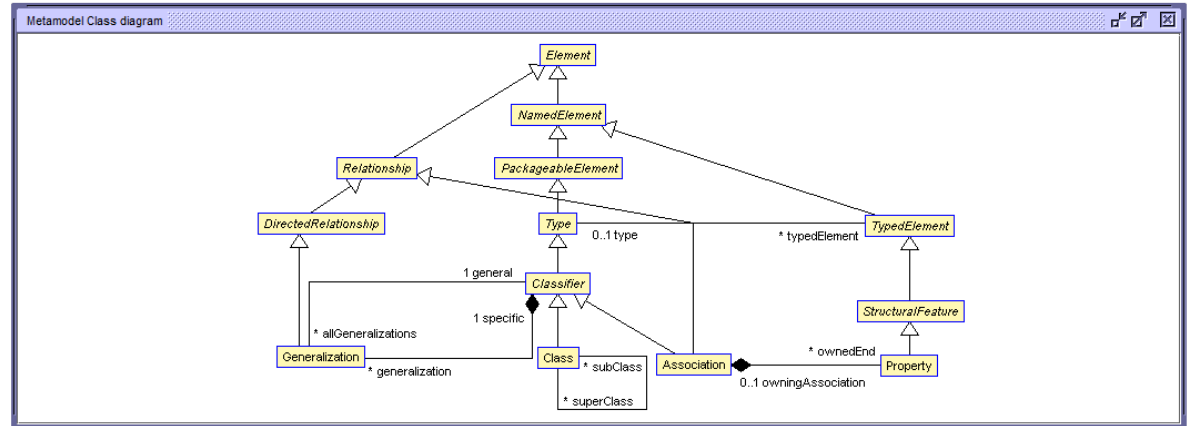

Behavioral Metamodels

- UML MM mainly describes structural aspects
- Behavioral aspects can be handled in metamodels as well
- Example: State machines
- General three level metamodel
- Realization in USE
- Metamodels with more than three levels possible

Three level metamodeling

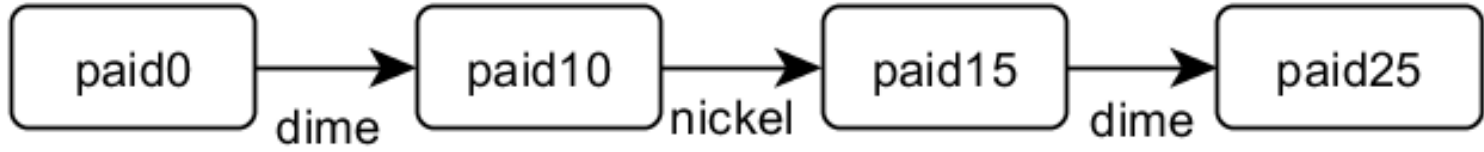
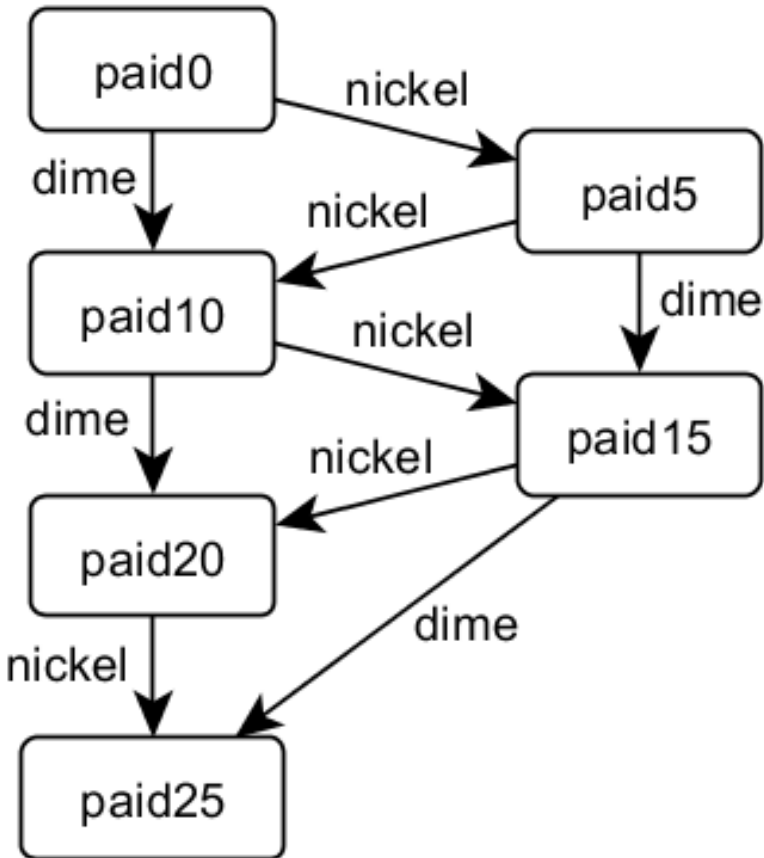
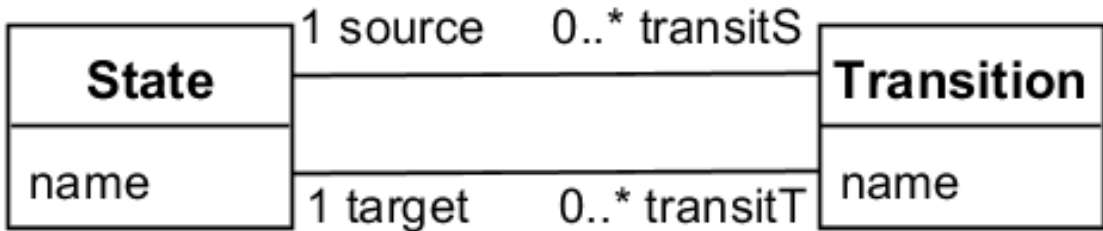
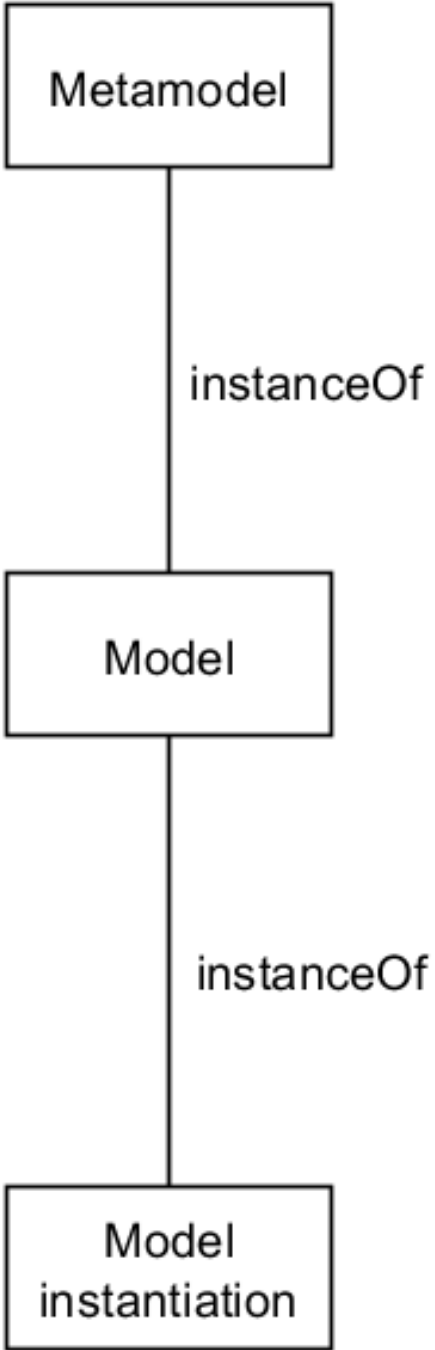

Nickel-Dime machine in USE

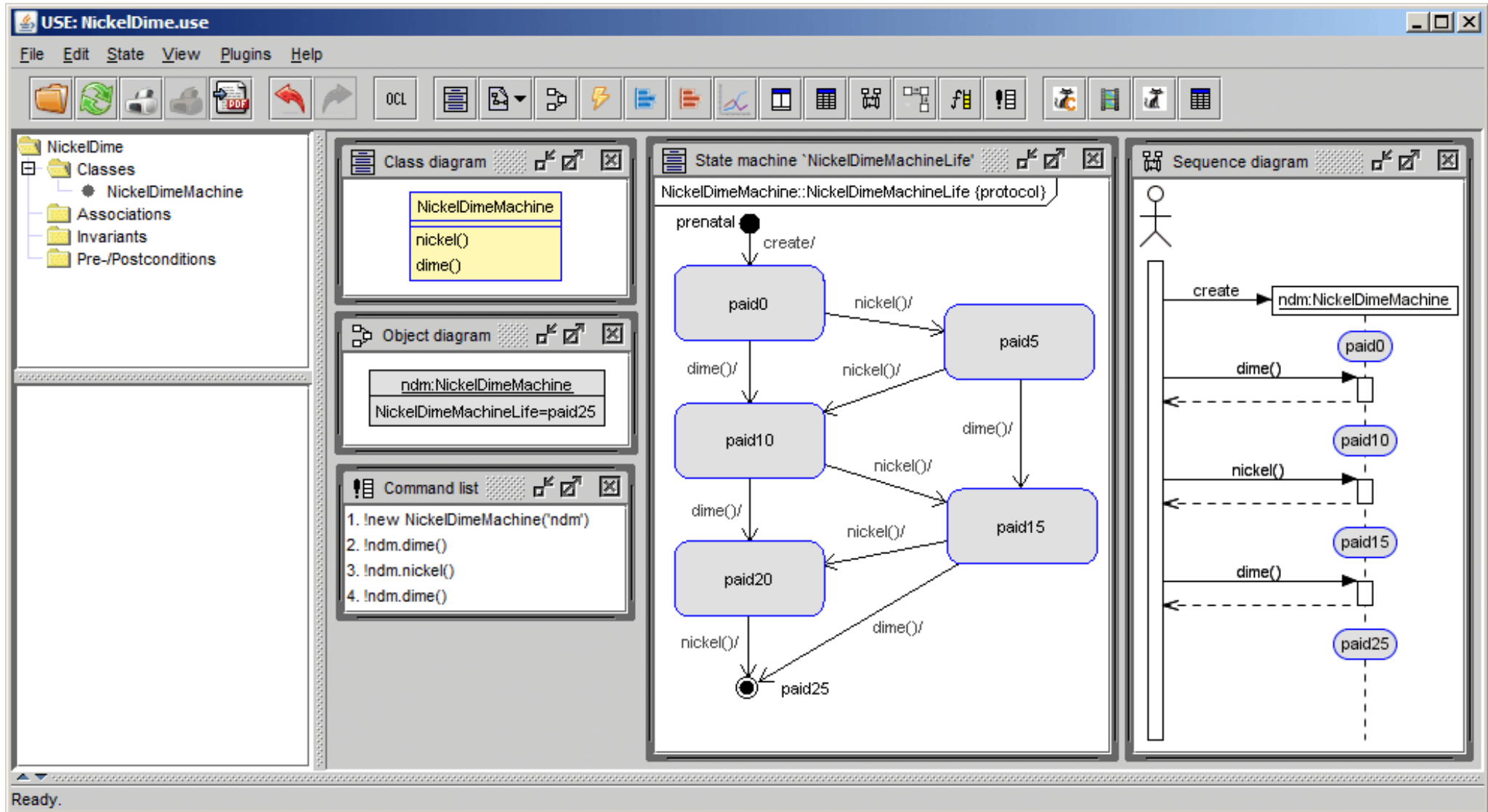

State machines in USE

USE: StatechartMM.use

File Edit State View Plugins Help

Statechart

- Classes
 - State
 - Transition
- Associations
 - Source
 - Target
- Invariants
- Pre-/Postconditions

association Source between
State[1] role src
Transition[*] role transitS
end

Object diagram

Class diagram

State	1 src	Source	* transitS	Transition
name : String				name : String
	1 trg	Target	* transitT	

Evaluate OCL expression

Enter OCL expression:

```
let S=State.allinstances in S->select(s | Set{s}->closure(sjs.transitS.trg)=S)
```

Result:

```
Set{paid0} : Set(State)
```

Ready.

Five level metamodeling

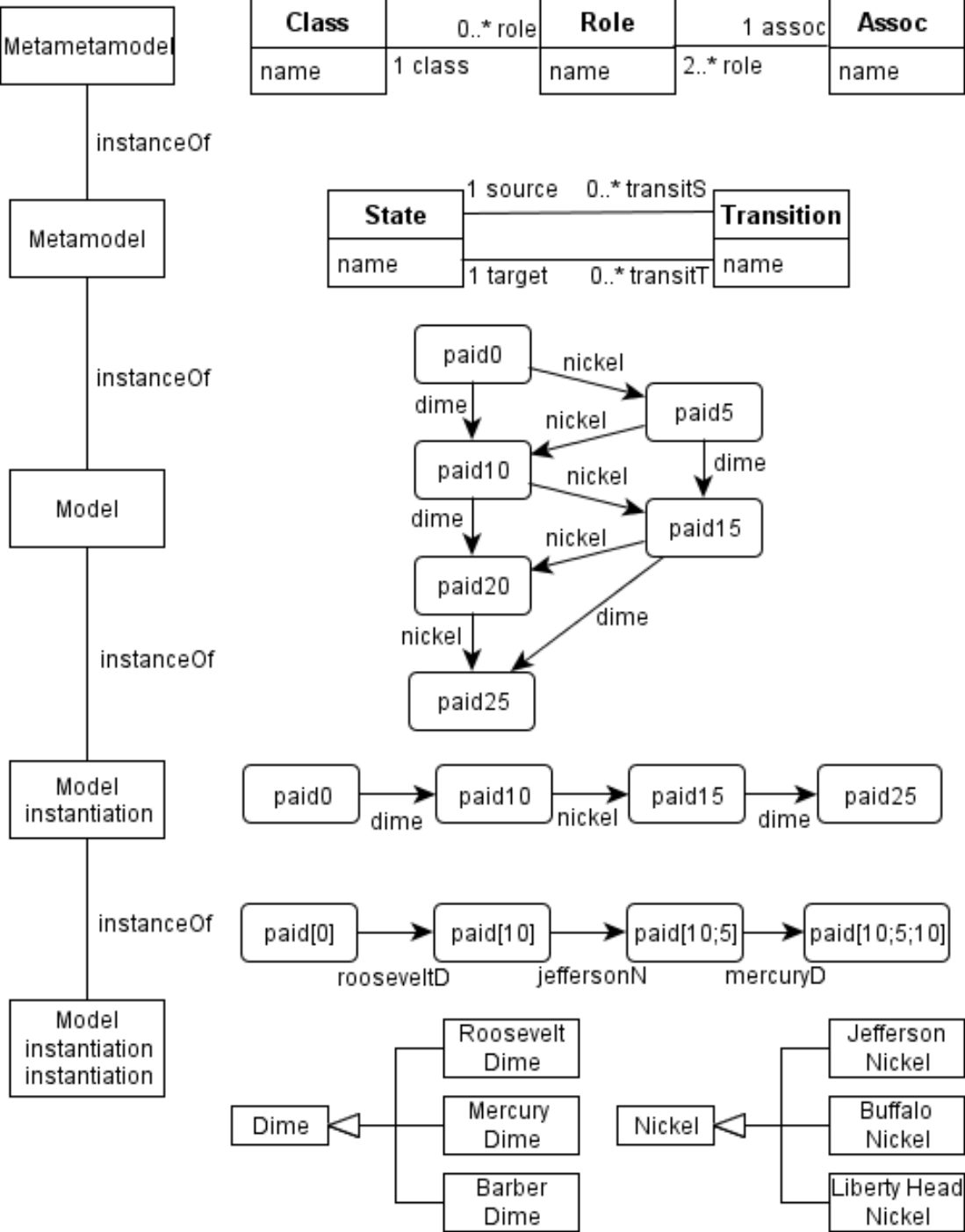

Metamodels: an alternative for language specification

- Usually languages in Computer Science are described with grammars together with an execution mechanism (operational evaluation)
- Metamodels present an alternative
- Syntax and semantics (execution) can be described
- Approach explained by means of a very simple programming language ProgLang
- Two examples
 - Factorial
 - Abstract example with all syntactical options
- Advantage of metamodels for language specification: common description technique (UML/MOF and OCL) for syntax and semantics (execution)

Metamodel for ProgLang Syntax and Semantics

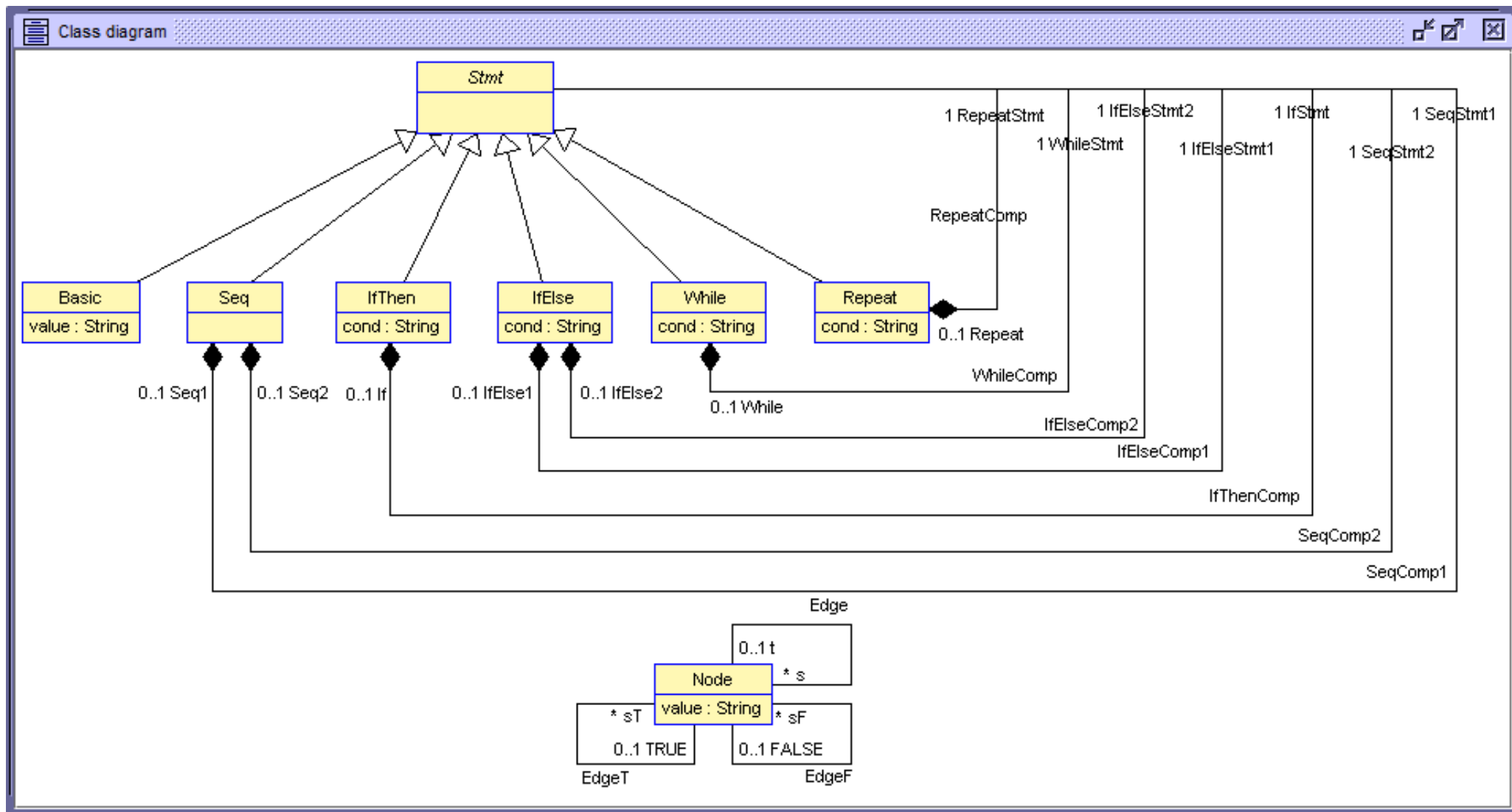

Context-free Grammar for ProgLang

statement ::= id |

statement; statement |

IF id THEN statement END |

IF id THEN statement ELSE statement END |

WHILE id DO statement END |

REPEAT statement UNTIL id

- Production grammar → New specialized class for Stmt
- Non-terminal statement on right side → Black diamond to Stmt
- Keywords (IF, THEN, ...) become part of an operation unparseS()

Factorial in ProgLang

- Left: syntax tree in form of an object diagram
- Utilizing UML composition is a natural way to build syntax trees; objects are connected to at most one aggregate; object diagrams with composition are acyclic
- Right: flow graphs in form of object diagram for 'compiled code' / execution
- Structuring control flow statements (if-then, if-then-else, while-do, repeat-until) have been represented by flows graphs
- Invariants (not shown) handle the connection between syntax and evaluation
- Operation `unparseS()` retrieves the source text from the syntax tree

Excursus: Composite pattern

- The composite pattern is a partitioning design pattern
- The composite pattern describes a group of objects that is treated the same way as a single instance of the same type of object
- The intent of a composite is to "compose" objects into tree structures to represent part-whole hierarchies
- Implementing the composite pattern lets clients treat individual objects and compositions uniformly
- The Client class does not refer to the Leaf and Composite classes directly (separately); instead, the Client refers to the common Component interface and can treat Leaf and Composite uniformly

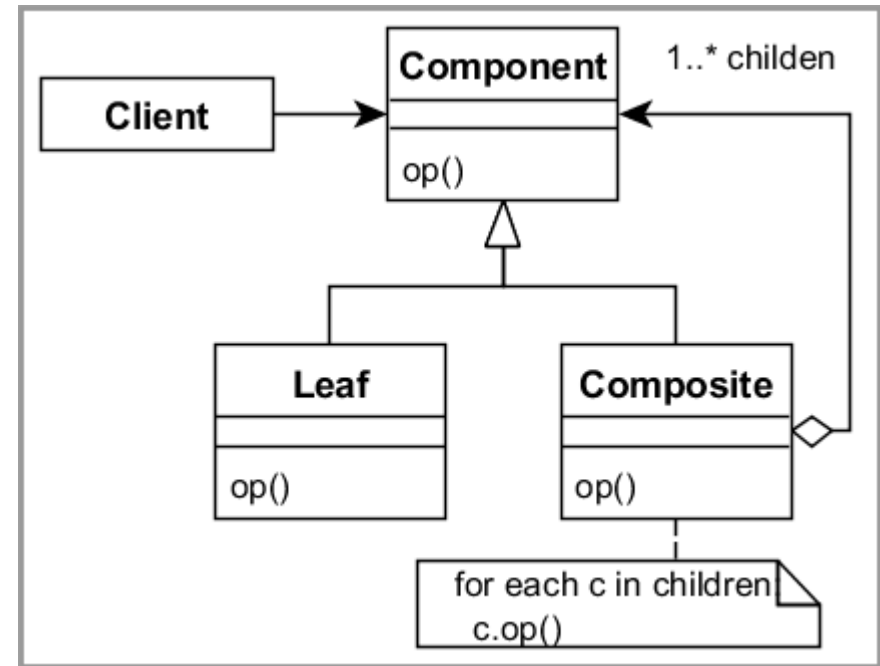

Operation unparseS()

```
Stmt::unparseS():String = null
```

```
Basic::unparseS():String = self.value
```

```
Seq::unparseS():String = self.SeqStmt1.unparseS().concat('; ').  
concat(self.SeqStmt2.unparseS())
```

```
IfThen::unparseS():String =  
  'IF '.concat(self.cond).concat(' THEN ').  
concat(self.IfStmt.unparseS()).concat(' END')
```

```
IfElse::unparseS():String =  
  'IF '.concat(self.cond).concat(' THEN ').  
concat(self.IfElseStmt1.unparseS()).concat(' ELSE ').  
concat(self.IfElseStmt2.unparseS()).concat(' END')
```

```
While::unparseS():String =  
  'WHILE '.concat(self.cond).concat(' DO ').  
concat(self.WhileStmt.unparseS()).concat(' END')
```

```
Repeat::unparseS():String =  
  'REPEAT '.concat(self.RepeatStmt.unparseS()).  
concat(' UNTIL ').concat(self.cond)
```

Abstract example in ProgLang

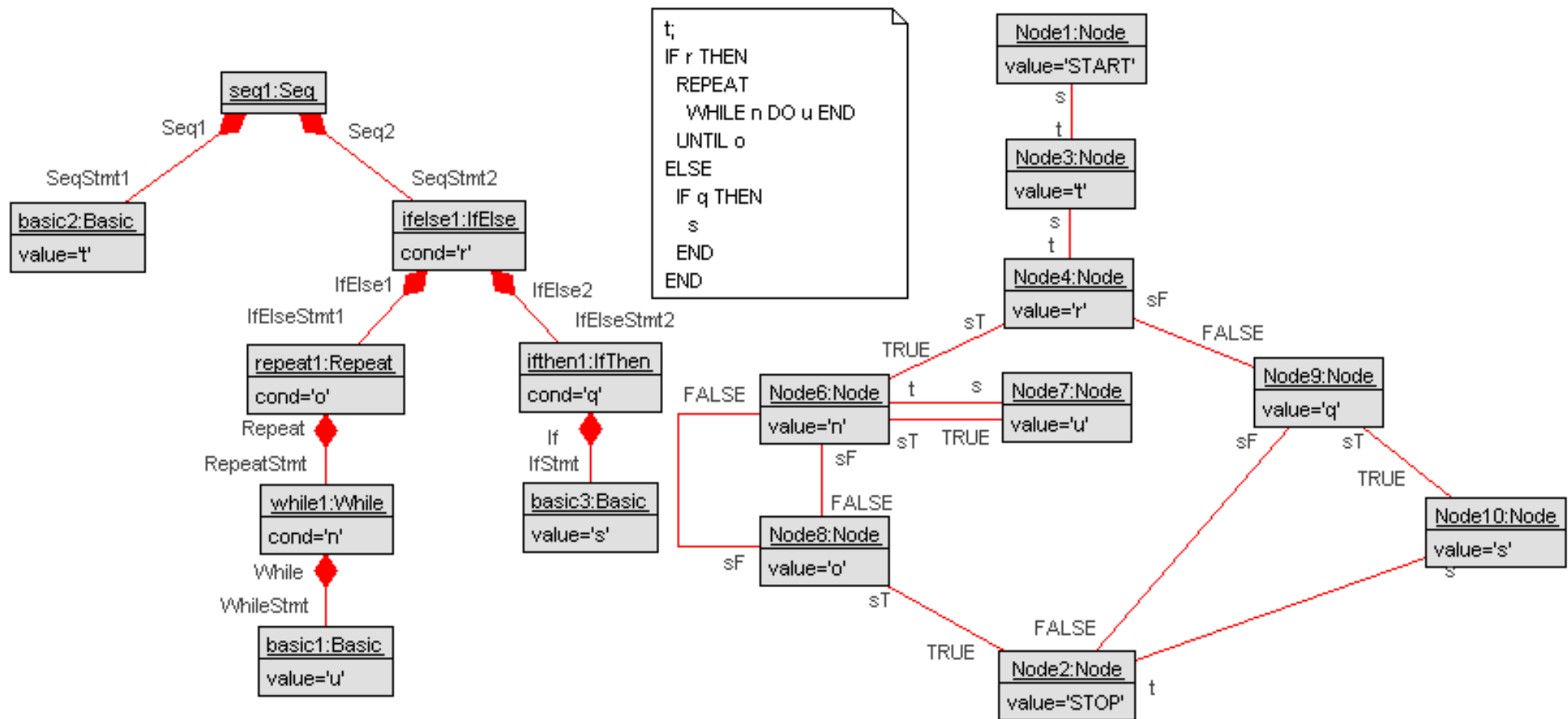

Thanks for your attention!